

**Square and Rectangular Ceiling Diffusers
Steel • Louvered Face • High Capacity**

Model: TDC • Square, Rectangle or Round Neck

Border Type 1 (Surface Mount) Square or Rectangular Neck

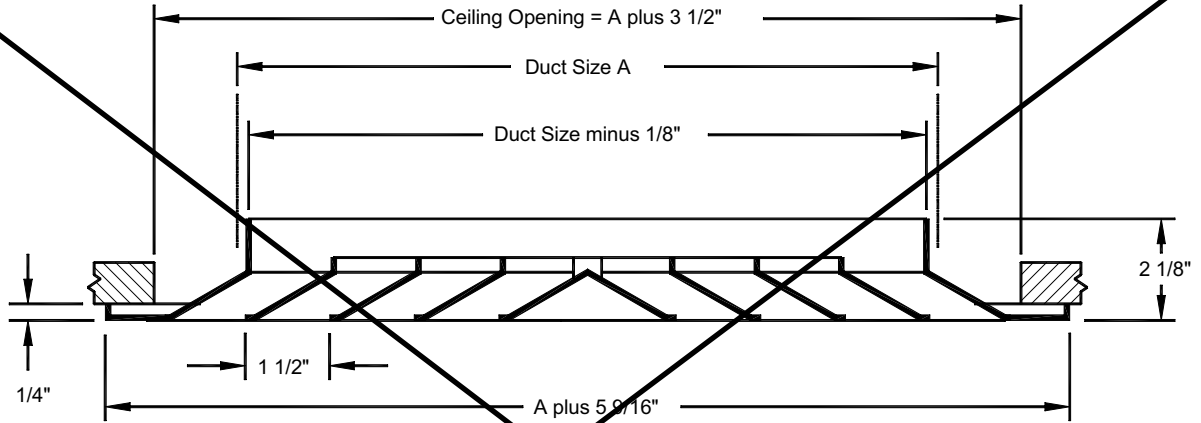

Border Type 1 (Surface Mount) Round Neck

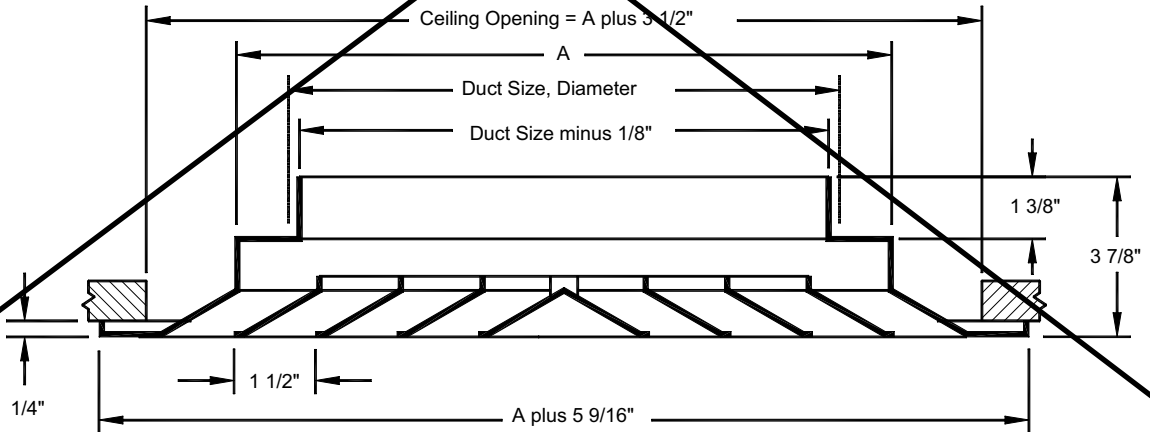

Border Type 2 (Snap-In)

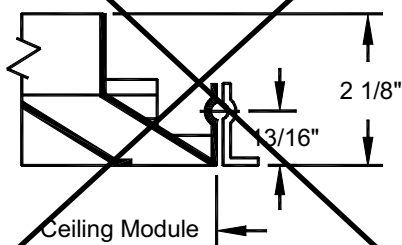

Border Type 3 (Lay-In)

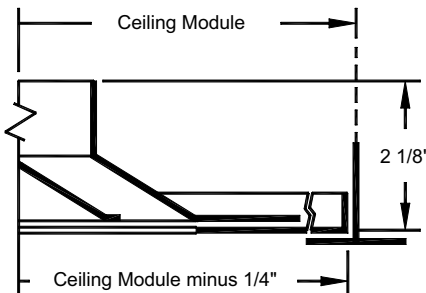

Border Type 4 (Spline)

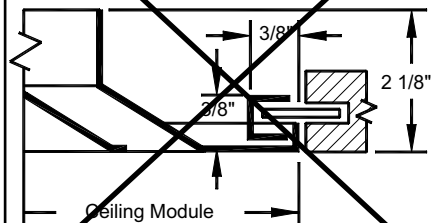

For Dimensions "A" see table on next page.

Dimensions are in inches.

D-38.0-S

(Please see reverse side).

Accessories (Optional) for Rectangular Neck

Check if provided

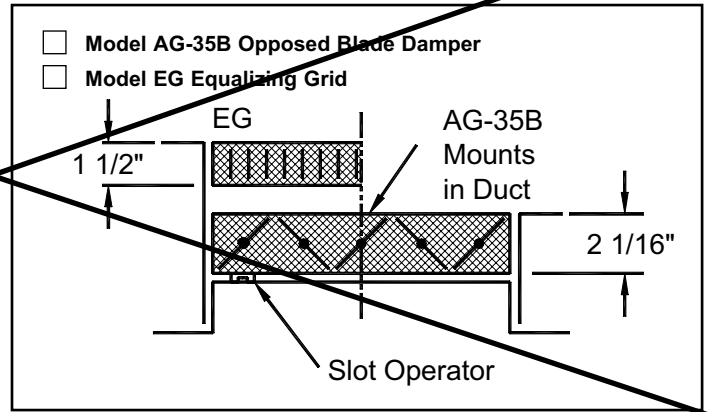
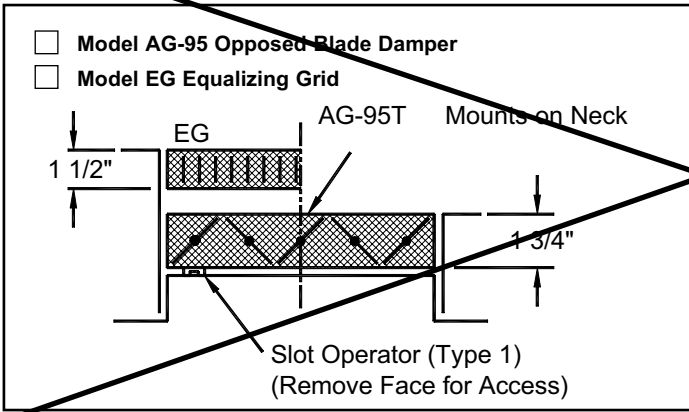

All dimensions are in inches.

Other Accessories (Optional)

Standard Finish: #26 White

- Model TRV Throw Reducing Vanes
- Model SR Square-to-Round Transition

Optional Patterns

Check selection

1 Way	<input type="checkbox"/> S1 Square	<input type="checkbox"/> A1	<input type="checkbox"/> B1
2 Way	<input type="checkbox"/> A2	<input type="checkbox"/> S2 Square	<input type="checkbox"/> B2
2 Way Corner	<input type="checkbox"/> E2	<input type="checkbox"/> F2	<input type="checkbox"/> G2 Square
3 Way	<input type="checkbox"/> A3	<input type="checkbox"/> E3	* Dimensions X and Y shown here are the proportions of available rectangular duct sizes. Duct sizes are available in 3" increments. Dimension X is always the longer dimension for each core option.
	<input type="checkbox"/> A3-2	<input type="checkbox"/> B3	
4 Way	<input checked="" type="checkbox"/> A4 Square	<input checked="" type="checkbox"/> B4	

Removing Center Core

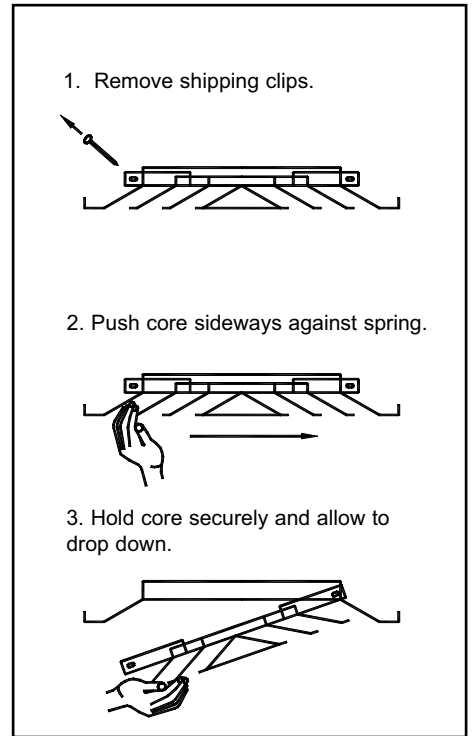

General Description

- TITUS Model TDC is a high capacity ceiling diffuser. Because it maintains an unbroken horizontal flow pattern from maximum cfm down to minimum, it is an excellent choice for variable air volume application.
- Core is removable from the face of the diffuser.
- Model TDC is extremely flexible, with cores available for 1, 2, 3 or 4-way horizontal flow patterns.
- Lever operator on optional Model AG-95 damper allows easy volume adjustment from the face of the diffuser. (Rectangular necks only).
- Material is heavy gauge steel.



Note: This submittal is meant to demonstrate general dimensions of this product. The drawing on this submittal are not meant to detail every aspect of the product with exactness. Drawings are not to scale. TITUS reserves the right to make changes without written notice.

D-38.0-S